

# Kit 4003

BMW X5, 5-dr SUV, 07-

This kit is only for vehicles with flush or integrated side railing.



460R  
753



460



**Kit**



753

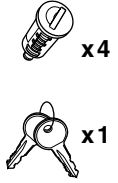
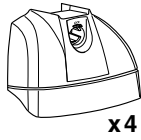

460R

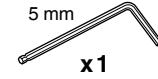
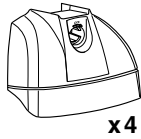
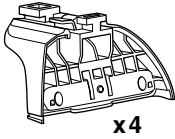

460

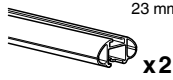
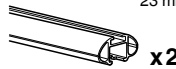
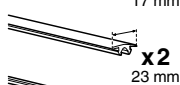
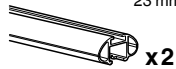
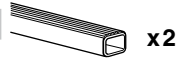
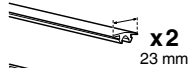
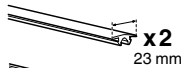
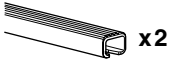
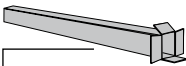
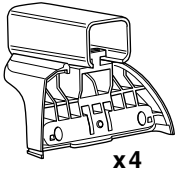

1

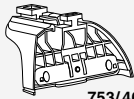

753/460R

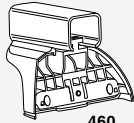

460

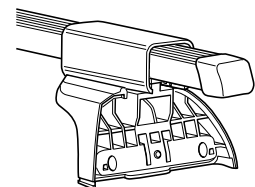
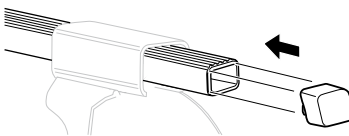
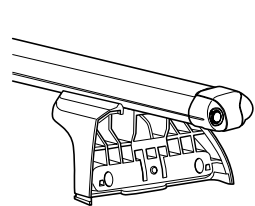
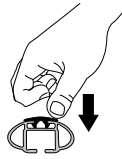
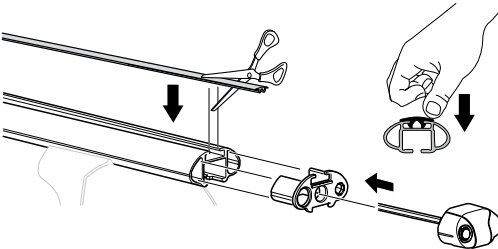
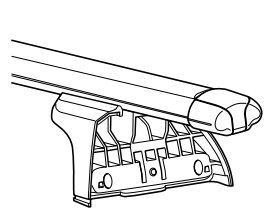
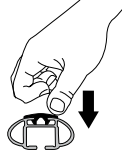
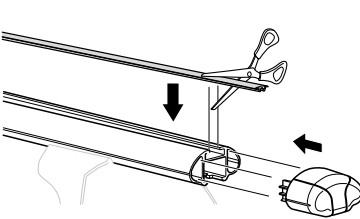
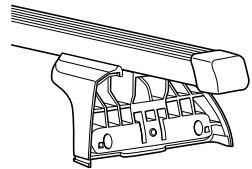
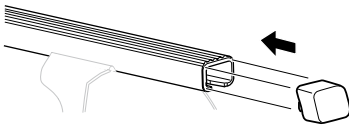
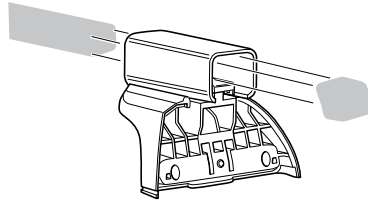
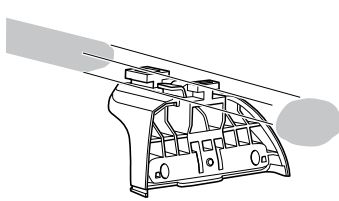

2

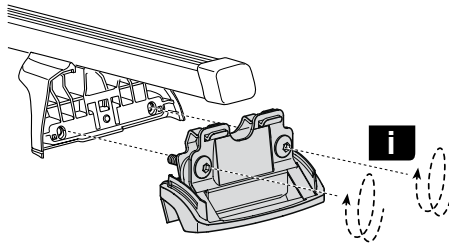
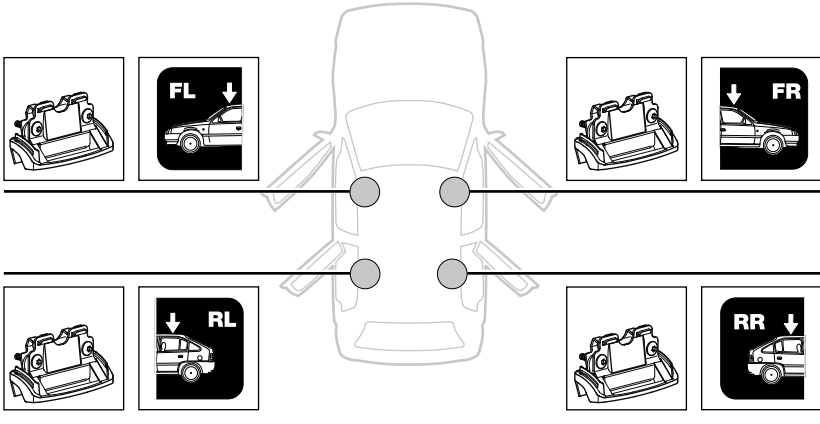
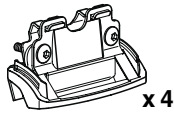

**i**

<b>GB</b> Only a few turns	<b>EST</b> Ainult mõni pööre	<b>HR</b> Samo nekoliko okreta
<b>D</b> Nur wenige Umdrehungen	<b>LAT</b> Tikai dažī apgriezieni	<b>HU</b> Csak néhány fordítás
<b>F</b> Quelques tours uniquement	<b>LIT</b> Tik keli pasukimai	<b>GR</b> Μόνο μερικές στροφές
<b>NL</b> Slechts enkele slagen	<b>PL</b> Wystarczy kilka obrotów	<b>TR</b> Yalnız birkaç kez çevirm
<b>I</b> Solo qualche giro	<b>RU</b> Достаточно нескольких оборотов	<b>中文</b> 只有几个转向
<b>E</b> Sólo algunas vueltas	<b>CZ</b> Pouze několik otáček	<b>한국어</b> 두 세번만
<b>PT</b> Noções básicas	<b>SK</b> Len niekoľko otáčok	<b>日本語</b> 数回転のみ
<b>S</b> Endast några varv	<b>SLO</b> Le nekaj obratov	<b>ไทย</b> หมุนเพียงไม่กี่รอบ
<b>FIN</b> Vain muutama kierros		

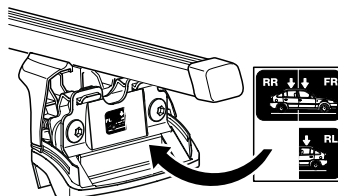

**3**

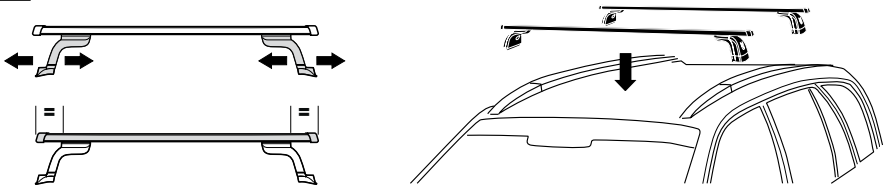

**A**

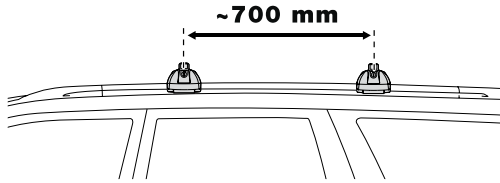

**B**

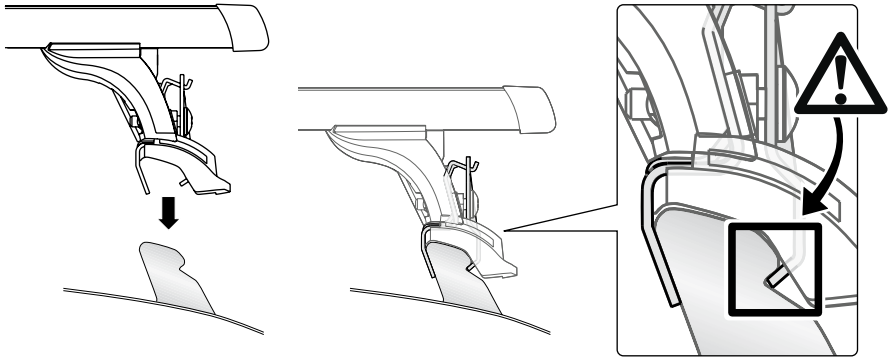

**C**

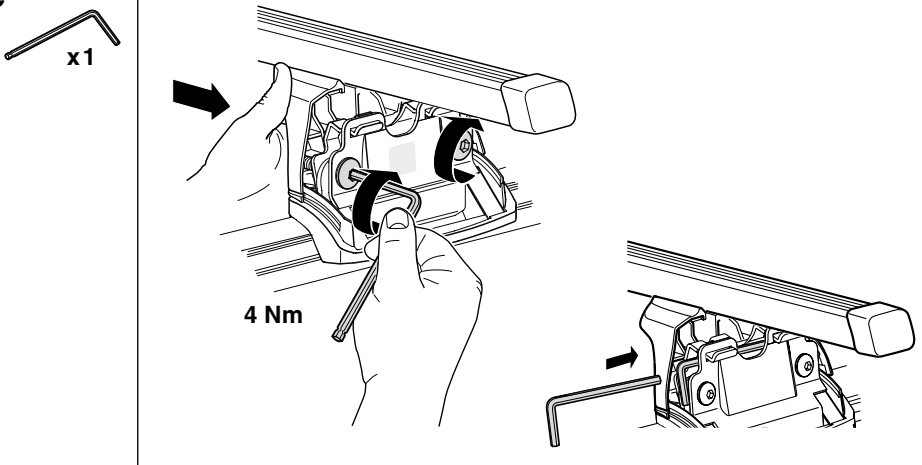

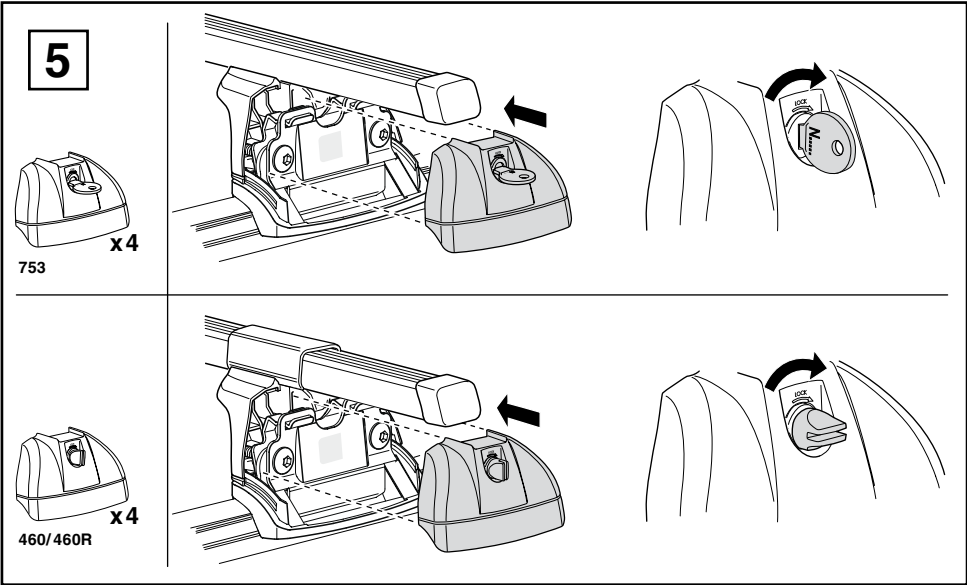
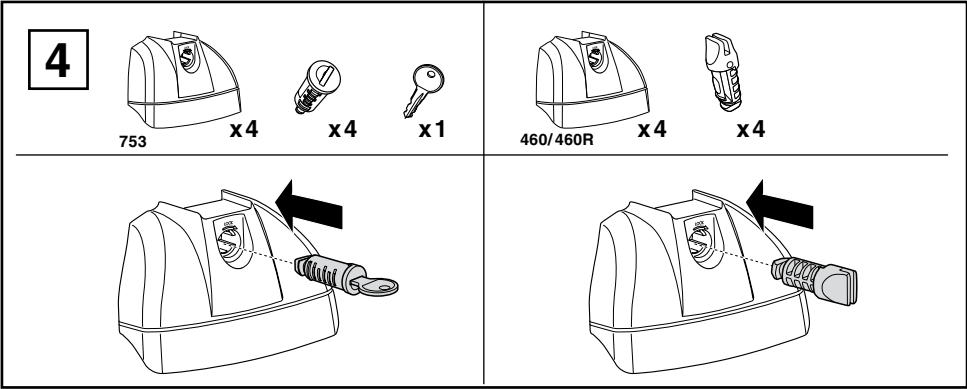

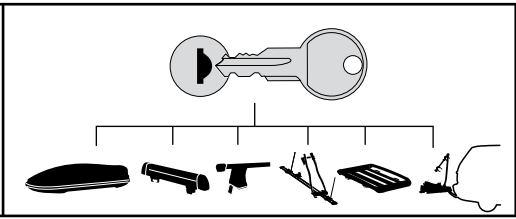
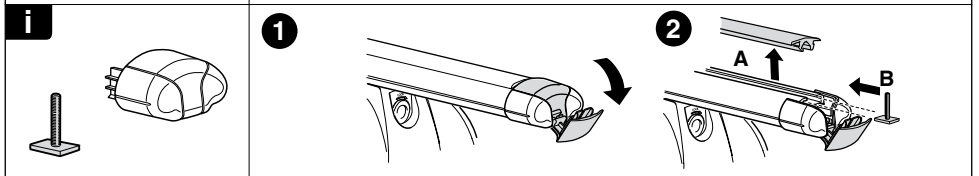
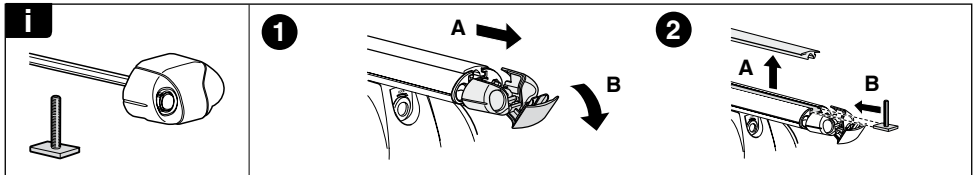
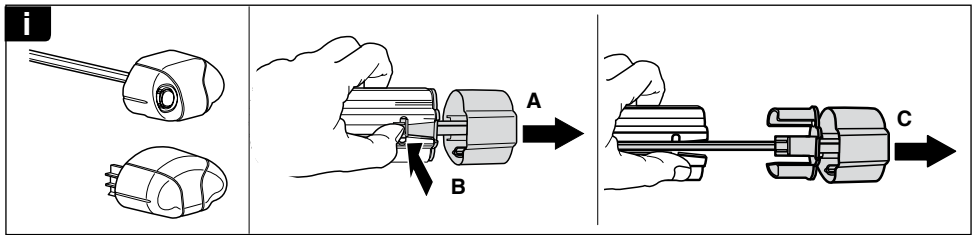
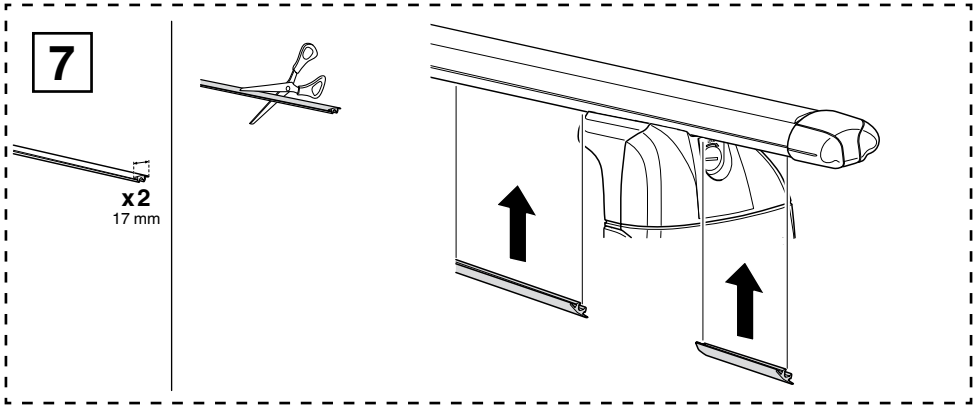

- 544 (x4)
- 596 (x6)
- 588 (x8)
- NA 510 (x10)
- EUR ASIA 452 (x12)

**WW** ▶ Thule Sweden AB, Box 69, 330 33 Hillerstorp, SWEDEN  
**NA** ▶ Thule Inc., 42 Silvermine Road, Seymour, Connecticut 06483, USA

info@thule.com  
 customer.service@thule.com

[www.thule.com](http://www.thule.com)